

Accessories: Mounting unit BES 18.0-KB-3-F-SA2

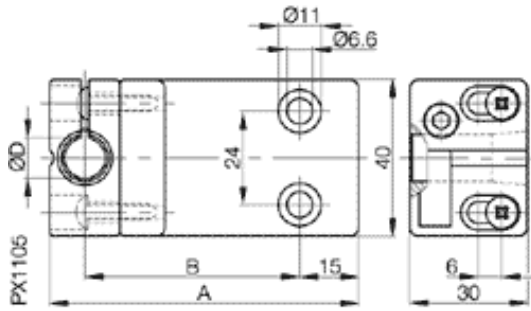

D = 18; A = 85; B = 58

Common Data

Version
Usable with

Clamp
clamp with positive stop for
horizontal insertion of sensors
M18

Mechanical Data

Measurements WxHxD or Dia x D
Material
Mounting

85x40x30
PA6 GK
2 screws DIN7981, ST4.2
galvanized

Datasheet number::

Definitions see general catalog.
If not otherwise noted, ratings according to
IEC 60947-5-2 (DIN EN60947-5-2)

Balluff GmbH
Schurwaldstrasse 9
73765 Neuhausen a.d.F.
Phone (07158) 173-0 Fax (07158) 5010

Datenblatt by CD-ROM - 04/2007

BALLUFF
sensors worldwide